

Wilfley

Drylock® Assembly

- General Installation
- Operating & General Servicing
- Clearance Settings
- Safety Precautions
- Spare Parts Ordering
- Assembly Instructions

Model S3

General Installation

Inspection upon Arrival

Your pump has been carefully inspected and tested prior to shipment to ensure that it meets your requirements. Please inspect the pump upon arrival for any damage that may have occurred during shipment. Report any damage immediately to the carrier.

Leave all shipping covers attached to the pump unit until it is ready for installation. If installation is to be delayed more than 15 days, the pump shaft should be rotated by hand once a week to lubricate the bearings and prevent rusting.

Choosing Pump Location

The following recommendations may be helpful when choosing the best location for your pump.

- Locate the pump as close to the liquid source as practical so the intake pipe is short and direct with a minimum of elbows, fittings and valves.
- Place the pump in a location so the unit is accessible for inspection during operation as well as for maintenance operations involving removal and disassembly.

Foundation

The foundation should be sufficient to absorb any vibration and to form a permanent, rigid support for the baseplate. This is important to maintain the correct alignment of the direct connected unit. A concrete foundation on a solid base is satisfactory. Foundation bolts of the proper size should be embedded in the concrete located as indicated on the outline drawing.

Alignment

The pump and motor are aligned at the factory before shipment. Realignment may be necessary after the complete unit has been leveled on the foundation and after the foundation bolts have been tightened. Procedures for checking and aligning the pump components may be found in the Hydraulic Institute Standards.

Piping

Both suction and discharge pipes should be supported independently near the pump so when the flange bolts are tightened no strain will be transmitted to the pump casing.

Discharge Piping

A valve should be installed in the discharge line to prevent fluid from flowing back through the pump when it is shut down. The valve should block the discharge line during maintenance.

Suction Piping

Care should be taken in sizing and locating suction piping to prevent cavitation. A valve should be installed in the intake line to prevent fluid from flowing into the pump when it is shutdown.

Auxiliary Piping - Purge Plumbing

When required, purge piping is supplied with the pump. External connection should be made at the pump so purge flow can be varied as required by valving and the pressure can be monitored. Piping fittings and gauges must be corrosion resistant to the fluid being pumped.

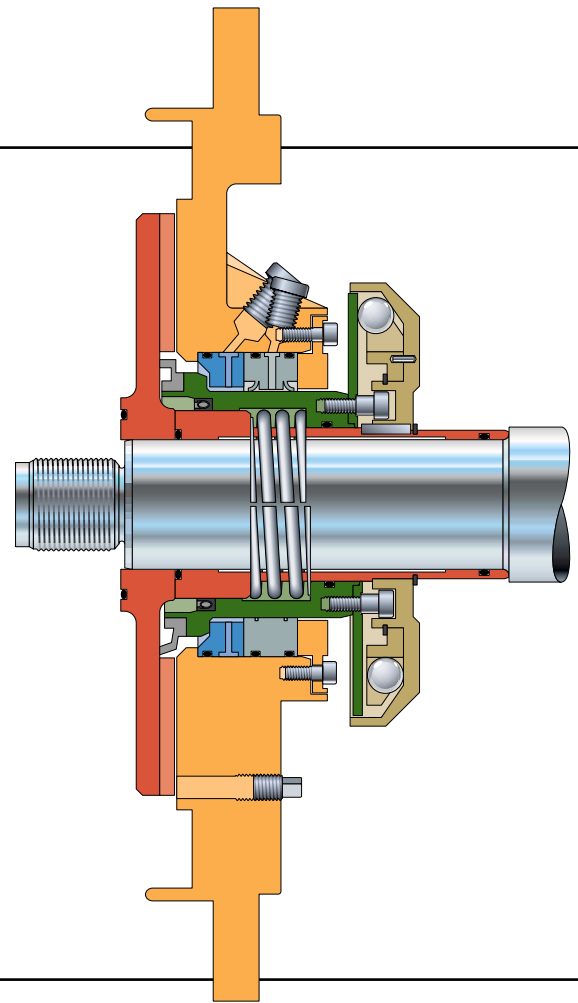

Pre-starting Recommendations

Please perform the following operations before attempting to start the pump.

- Visually check all main and auxiliary piping to ensure that all connections have been properly made.
- The oil level in the frame should be to the middle of the glass. If oil is low, fill with clean oil.
- Check voltage, fuse, starter amperage ratings and frequency on the motor nameplate against the electrical supply characteristics.
- Visually inspect all electrical connections to the motor and control circuit.
- Check the rotation of the motor by momentarily starting the motor with the motor disconnected from the pump assembly. Direction of rotation must be as shown by the arrow on the pump case and the direction of rotation plate on the top of the frame. Starting or running pump backwards will cause damage to internal parts.

Starting

Before starting the pump, it is advisable to have the pump casing and suction line filled with liquid. It is normal to have the discharge valve momentarily closed when the pump is started since much less horsepower is required under these conditions.

DO NOT OPERATE THE PUMP IN A DEAD-HEADED (NO FLOW) CONDITION.

Shutdown

Close the suction valve and discharge valve, and then stop the pump.

General Servicing

Your Wilfley Model S3 pump is designed to provide long and trouble-free service with a minimum of maintenance. It is recommended that the pump be inspected at

regular intervals. It is also suggested that a service record be kept for the pump.

Motor

Please refer to the manufacturer's motor manual for recommended service instructions. It is recommended that the motor be well ventilated when in operation.

Pump Storage

If the pump is inoperative for a long period of time, it is recommended that the pump be flushed and drained to minimize corrosion. It is

also advisable to drain the lines and case if there is a possibility of freezing. If the pump is to be stored for more than 15 days, the pump should be rotated once a week to lubricate and to prevent rusting of the bearings.

Oil capacities

Frame 1	1600 ml
Frame 2	5000 ml

Periodic Servicing

The following table contains recommended service checks that should be performed on a periodic basis.

	Upon Installation	After First Start-Up	Every Week	Every Month	Every 6 Months
Flow, Pressure and Temperature (a)		●	●		
Oil Level (b)	●	●	●		
Visual (c)		●	●		
Noise/Vibration		●	●		
Oil Change					●

a. Flow, Pressure and Temperature:

All flow pressure and temperature gauges should be monitored to ensure that the pump is operating within specified limits. If the frame bearing temperatures are monitored, this temperature should not exceed 220°F (104°C).

b. Oil Level:

A window sight glass is provided for easy monitoring of the oil level. The oil supply should be visible in the middle of the window sight glass. Add clean oil when needed. Oil should be periodically checked to be sure lubricant is clean.

c. Visual:

Periodic visual inspection should be made of the pump and its installation. This inspection should include the following:

- All mounting supports should be secure.
- All external nuts, bolts and fittings should be tight.
- All suction and discharge piping should be secure.
- All surfaces and joints should not show signs of leakage.

Acceptable Oils

Chevron	GTS oil 68
Exxon	Teresstic EP 68
Gulf	Gulf Harmony 68
Mobil	Mobil DTE 26 300 SSU 38°C (100°F)
Phillips	Mangus Oil Grade 315
Phillips	MM motor oil SAE 20-20W
Phillips	HDS motor oil SAE 20-20W

Lubricating Oil Requirements

	Bearing temperature below 82°C (180°F)	Bearing temperature above 82°C (180°F)
ISO Grade	VG 68	VG 100
Approx. SSU @ 38°C (100°F)	300	470
DIN 51517	C68	C100
Kinem. viscosity at 40°C (105°F) mm ² .sec	68	100

Dial Indicator Method



1. Loosen cap screws and the nuts on jacking cap screws. Tighten the jacking cap screws to pull the rear bearing carrier out from the frame until the shaft will not turn due to metal to metal contact in the pump.
2. Set dial indicator so that the button contacts the end of the shaft. Set indicator at a minimum of 0.04".
3. Draw the bearing unit into the frame with the cap screws 0.02". Evenly tighten all screws and nuts. Check the indicator to insure the proper clearance has been maintained.
4. Check the shaft to be sure it turns freely.

Feeler Gauge Method



1. Loosen cap screws and the nuts on jacking cap screws. Tighten the jacking cap screws to pull the rear bearing carrier out from the frame until the shaft will not turn due to metal to metal contact in the pump.
2. Measure the total clearance between frame and bearing unit. Draw the bearing unit into the frame with the cap screws until the gap is 0.02" less than the original measurement.
3. Evenly tighten all screws and nuts. Re-measure the gap between the frame and the rear bearing carrier in several places to insure proper clearance has been maintained.
4. Check shaft to be sure it turns freely.

Safety Requirements

Like all machinery, centrifugal pumps can be dangerous if used improperly. Any of the following list of misuses may result in a pump that does not function properly. A pump that does not function properly may be a hazard and could cause damage or injury.

For maximum safety and reliability, use only factory supplied parts and closely follow all maintenance and operating recommendations and instructions.

Do not change the pumping conditions or installations of a Wilfley pump without consulting A.R. Wilfley & Sons, Inc. first to ascertain if the pump is capable of handling the new conditions and/or fluid.

It is not possible to list all the conceivable misuses. Therefore, the following list is not meant to be complete and is provided only as a guide of the types of misuse that can damage a pump and cause injury. The list will also give a good idea of the kinds of misuses that will void any and all warranties.

1. Do not run a pump with the discharge valve closed.
2. Do not run a pump in the reverse direction.
3. Do not start a pump that is "windmilling" in the reverse direction due to fluid flowing back down the discharge pipe.
4. Do not continue to operate a pump when there are indications that something is rubbing, binding or knocking.
5. Do not continue to run a pump that gives an indication of overheating.
6. Do not operate a pump with the belt or coupling guard removed. Make sure the guard fits snugly around the belts or couplings so there are no openings.

7. Do not operate a pump that is vibrating, surging or making abnormal noise.

8. Do not work on a pump unless the drive system is locked out and the pump is disconnected from the drive system.

9. Do not connect the pump to the drive system without first checking to see that the drive system is running in the correct direction.

10. Do not rely on the factory's alignment of the pump and the drive system. Alignment may have changed during shipment.

11. Do not put a cold liquid in or on a hot pump or a hot liquid in or on a cold pump.

12. Do not hit a pump with any object.

13. Do not use worn or faulty parts.

14. Do not stick hands, arms, legs or any other object into the discharge, suction or any other opening of a pump.

15. Do not weld attachments to the pump.

16. Do not apply external heat to the pump.

17. Do not lift the pump by its case only.

18. Do not examine a pump without using proper eye and face protection.

Parts Ordering

Please include the serial number of your pump when ordering spare parts. With this number we can determine and duplicate the original configuration and materials of construction.

Special Service

The seal assembly is extremely important to the total, efficient operation of Wilfley S3 pumps. Its parts, gaskets and seals must be in good working order. Many times parts are replaced unnecessarily due to the unfamiliarity with the assembly. The reverse is also true, parts that should be replaced are, at times, left in the assembly. For these reasons, we provide the service of rebuilding this assembly in our factory.

Your Wilfley S3 pumps and seals may be returned to the factory, at any time, for complete overhaul and repair. Each pump is completely disassembled and worn or inoperable parts are replaced. All rebuilt pumps are subjected to the same testing procedures as newly constructed units. We charge the standard price for parts and a minimal reassembly fee.

The utilization of this service provides you with almost instantaneous pump repair at an economical price. The units are overhauled and returned to you quickly.

Please contact A.R. Wilfley & Sons or any of our representatives at any time, concerning our pumps or parts. You can be assured that we will do all within our power to ensure your complete satisfaction with Wilfley products.



A.R. Wilfley & Sons, Inc.
P.O. Box 2330
Denver, Colorado 80201
1-303-779-1777
1-800-525-9930
www.wilfley.com



1. Install Outboard Bearing (62b) and Locknut (62c) on the shaft (62).



2. Slide Retaining Ring (73) onto shaft, be sure chamfered edge faces away from rear bearing. Install the Inboard Bearing (62a) onto shaft, being sure the bearing groove faces in (stamped side out). Frame 2 requires a cylindrical roller bearing. Install the bearing washer on the shaft prior to the bearing body.



3. Slide the Bearing Carrier (72) onto rear Outboard Bearing and secure with Retaining Ring (73). Extreme Duty Bearings have a Bearing Plate (74) that bolts to the Bearing Carrier instead of a Retainer Ring.

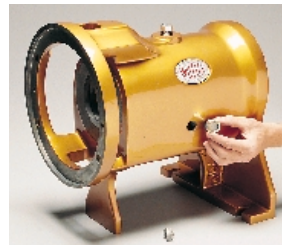

4. Install Breather (61a), Drain Plug (61b), and Sight Cage (79) into Frame (61). Check inside of the frame for contaminants and be sure the oil seal surfaces are clean.

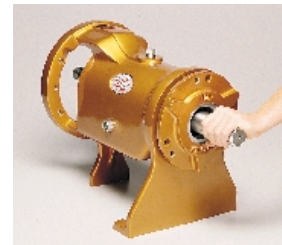

5. Slide the Shaft Assembly into the Frame.



6. Secure the Shaft Assembly to the Frame. Install the Outboard Oil Seal (76) being careful not to damage O-Rings during installation. Some seals have a drain on the bottom. Be sure the seals are installed properly.

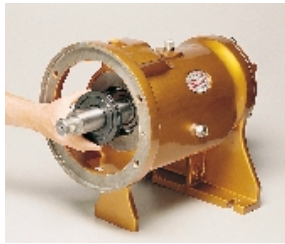

7. Install Inboard Oil Seal (67) into Frame. Check the seal specifications to be sure it is installed properly.



8. Place Slide Rings (24a & b) into bore of Rotary Seal Housing (24). The shorter Slide Ring goes to the rear of the housing. There will be a small gap in the circumference of the seals.



9. Insert the lip seal (25) into the Rotary Seal Housing, be sure the spring faces out. The seal must seat completely in the groove of the housing.

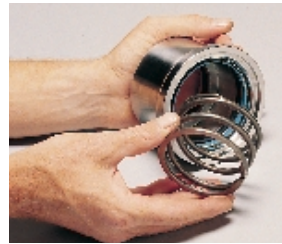

10. Insert Spring (42) into the bore of the housing, be careful not to damage the lip seal.

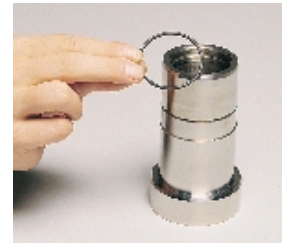

11. Place one Shaft Sleeve O-Ring (18) into the groove on the inside of the Shaft Sleeve (39).



12. Slide Rotary Seal Housing over the Shaft Sleeve. Be careful not to damage the lips of the seal. The Seal Housing (30) must fit completely over the sleeve. Rotate the keyway until it is halfway between the drive screw holes.



13. Carefully inspect Stationary Seal Ring (23) before installation. The inside surface is the stationary seal face and must be free of scratches or nicks. Insert the seal into the bore of the Seal Housing with the seal face down.



14. Place the Labyrinth Seal or Lube Seal (28) into the bore of the Seal Housing. These seals are symmetrical and can be installed either way.

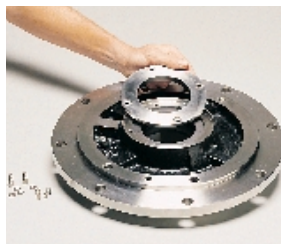

15. Secure the Seal Retainer (26) to the Seal Housing. Lockwashers (26a) must be installed concave side down to insure Cap Screws (26b) stay tight.



16. Slide the Seal housing assembly onto the Shaft Sleeve Assembly, be careful not to damage the lips of the Stationary Seal during installation.

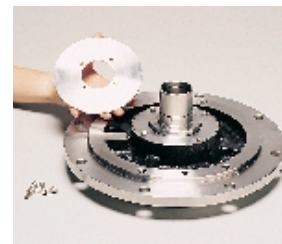

17. Attach the Actuator Plate (43) to the Shaft Sleeve Assembly. The notch on the ID faces down. Be sure the Drive Screws (24c) are securely tightened. Use Loc-Tite® 261 or equivalent on the threads of the screws.

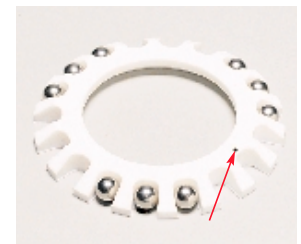

18. Place the Balls (40a) into the slots of the Ball Retainer (40). The balls must be symmetrically placed. Please note the small hole on the face of the Ball Retainer, this hole will fit over the Spring Pin (34b) in the Ball Housing (34).



19. Set the Ball Housing on top of the Ball Retainer, be sure the Spring Pin is installed and fits into the hole of the Ball Retainer. Turn the assembly over.



20. Attach the Retaining Ring (34a) to the hub of the Ball Housing.



21. Slide the Key (34c) into the slot on the Shaft Sleeve, push down to compress the seal assembly to get the proper fit. A small block placed under the Shaft Sleeve will be necessary to fully compress the assembly. Rotate until the keyway is halfway between two drive screws.



22. Place the Ball housing over the seal assembly, be sure the Drive Screws are seated in the Ball Housing. Press down and compress seal assembly to fit the Retaining Ring (39a) into its groove.

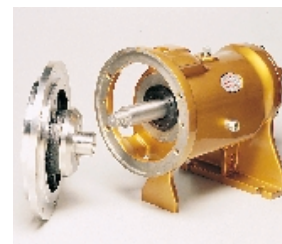

23. Install the seal assembly to the Frame, be careful not to damage the Shaft O-Ring during assembly. Secure the assembly to the Frame.

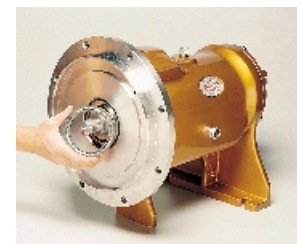

24. Install the Barrier Ring (35) to the hub of the Rotary Seal Housing.



25. Slide the second Shaft Sleeve O-Ring (18) onto the Shaft and install the Expeller. Be sure the O-Ring is seated into the groove on the Shaft Sleeve.



26. Install the Seal Housing Gasket (30a) and Case Plate (15) to the Frame. The Studs (15a) go through the Frame, and secure with Nuts (15b).

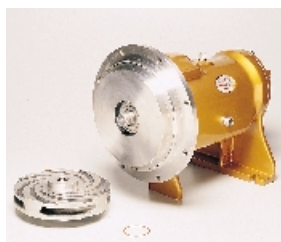

27. Install Expeller O-Ring (19) into groove on the Expeller and install the Impeller (14).

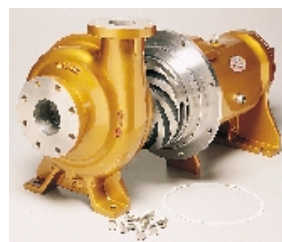

28. Install the Case Gasket (3) and Case (1) onto the Frame. Be sure the Frame is filled with lubricant to the proper level.

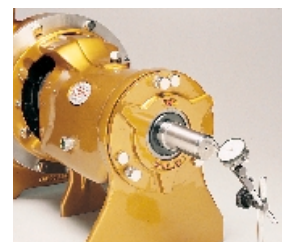

29. For maximum efficiency and proper seal action, please set clearances within the pump. Please follow the directions on the back of this poster to set clearances.

Please refer to the pre-starting instructions on the back of this form. Be sure the shaft turns freely with a slight drag from the seals. Please follow all safety precautions and be sure all safety guards are in place. These instructions are intended to help you assemble your pump. The photos depict a Model S3 frame 1, metal pump. Please follow all safety requirements and technical information found on the reverse side of this poster. For assistance, call (303) 779-1777 or (800) 525-9930.

